



---

# TEAM PHUN

---

**CUSTOM MERCH ★ SIGNS AND DISPLAYS**  
**BRANDED APPAREL ★ DIGITAL SERVICES**

---

## SUMMER PHUN 2022 CATALOG

### **SAN DIEGO HEADQUARTERS**

5026 Cass St.  
San Diego, CA 92109  
(858) 598-5563 x 2  
info@teamphun.com



### **CHARLESTON SHOWROOM**

2157 Rich St, Suite 601  
North Charleston, SC 29405  
(858) 598-5563 x 3  
info@teamphun.com



**SUMMER  
PHUN**



## ORU KAYAK

One seamless sheet of corrugated plastic quickly transforms to a boat using origami folds to deliver incredible performance and lightweight materials making it easy to handle. Add your brand and help create good moments on the water for years to come.

**CALL FOR A CUSTOM QUOTE**



Inlet



Beach LT

LENGTH	9'8"	12'1"
WIDTH	31"	29"
WEIGHT	20 lbs	25 lbs
CAPACITY	275 lbs	300 lbs

\*Inventory subject to change. Please confirm stock with your sales rep

**CONTACT YOUR LOCAL SALES REP FOR MORE INFORMATION**

YOUR  
BRANDING  
GOES  
HERE



## ISLE SURF AND SUP

Unlock summer fun with a paddleboard from ISLE! These boards are perfect for anyone who is looking for a great outdoor recreational water activity. Take your company out on the lake or the bay for a day and customize these paddleboards. They can also be great gifts or incentives for employees!

## CALL FOR A CUSTOM QUOTE

SUMMER  
PHUN



YOUR  
BRANDING  
GOES  
HERE



Pioneer

Explorer

Scout

Megalodon  
12' or 15'

LENGTH	10'6"	11'6"	11'	12'   15'
WIDTH	34"	32"	33"	45"   56"
THICKNESS	6"	6"	6"	8"   8"
VOLUME	326 L	336 L	345 L	584 L   730 L
WEIGHT	24 lbs	24 lbs	21 lbs	34 lbs   50 lbs
CAPACITY	285 lbs	300 lbs	315 lbs	650 lbs   1050 lbs

\*Inventory subject to change. Please confirm stock with your sales rep



CONTACT YOUR LOCAL SALES REP FOR MORE INFORMATION



# SUMMER PHUN

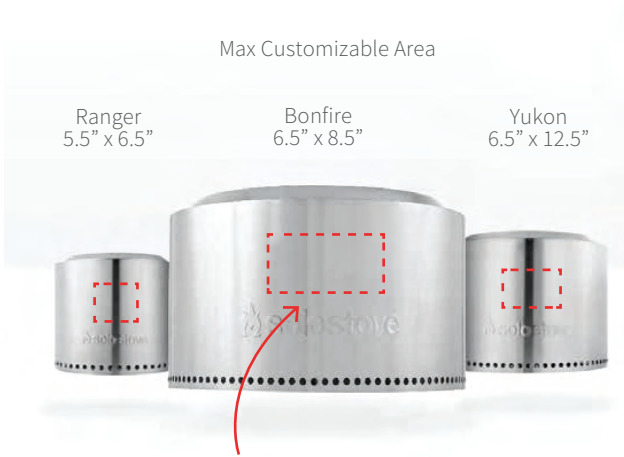

Max Customizable Area

Ranger  
5.5" x 6.5"

Bonfire  
6.5" x 8.5"

Yukon  
6.5" x 12.5"

**YOUR BRANDING  
GOES HERE**

## SOLO STOVE

Enjoy a great summer night with the Solo Stove Fire Pits! Solo Stove signature 360-degree airflow design creates a super-efficient burn and minimizes the effect of campfire smoke on clothes, hair, and other items.

This is a perfect item for giveaways, tailgates, or to create memories around. Get your company-branded fire pit today!

## CALL FOR A CUSTOM QUOTE

Ranger	Yukon	Bonfire
HEIGHT 12.5"	HEIGHT 15.5"	HEIGHT 14"
WEIGHT 15 lbs	WEIGHT 40 lbs	WEIGHT 20 lbs
DIAMETER 15"	DIAMETER 27"	DIAMETER 19.5"
MATERIAL 304 Stainless Steel	MATERIAL 304 Stainless Steel	MATERIAL 304 Stainless Steel

\*Inventory subject to change. Please confirm stock with your sales rep

**CONTACT YOUR LOCAL SALES REP FOR MORE INFORMATION**



**SUMMER  
PHUN**



## CUSTOM POOL NOODLES

Summer time is here, and that means hanging out by the pool! Make a splash with this awesome custom product! These foam pool noodles are covered in a silky fabric with full color graphics - great for custom branding.

## CALL FOR A CUSTOM QUOTE



\*Inventory subject to change. Please confirm stock with your sales rep

**CONTACT YOUR LOCAL SALES REP FOR MORE INFORMATION**

**SUMMER  
PHUN**



## **CUSTOM CORRUGATED CORN HOLES**

Need some fun games for a company picnic or just to hang around the office? Pick up some fully custom corn hole boards! Not only are these fully custom, but they are made from a highly durable corrugated board! Yes! Corrugated! They are light and easily maneuverable.

This includes 2 boards and 8 bags.

Get your company-branded corn hole boards today!

**CALL FOR A CUSTOM QUOTE**



\*Inventory subject to change. Please confirm stock with your sales rep

**CONTACT YOUR LOCAL SALES REP FOR MORE INFORMATION**



**SUMMER  
PHUN**



## SUBLIMATED TOWELS

Take your towel game to the next level and invest in some high quality fully sublimated custom towels! Great for your outdoor events like company picnics, concerts, hanging by the pool, and much more!

Let these beautiful custom towels push your branding to the next level!

## CALL FOR A CUSTOM QUOTE



\*Inventory subject to change. Please confirm stock with your sales rep

**CONTACT YOUR LOCAL SALES REP FOR MORE INFORMATION**



# SUMMER PHUN



## FULL CUSTOM LIFEGUARD HATS

We can create custom lifeguard hats branded with your logo on a front patch and even a branded under-brim! Keep it classic with a woven patch to show off your brand or create a fully sublimated patch with embroidered text to give it a unique look. If you are looking for something a bit more special, work with Team Phun's design team, we can even build custom artwork to show off and add to the under-brim of straw lifeguard hats!

**CALL FOR A CUSTOM QUOTE**

## LIFEGUARD HATS WITH PATCHES

If you aren't looking for fully custom lifeguard hats the next best option is sewing a patch on! All the protection of a full brimmed lifeguard hat with your company or client's patch right in the middle!

**CALL FOR A CUSTOM QUOTE**

Standard sewn patch to lifeguard hat



\*Inventory and pricing subject to change confirm with your sales rep

**CONTACT YOUR LOCAL SALES REP FOR MORE INFORMATION**

# SUMMER PHUN



Cropped Hoodies



Hooded Sweatshirts

## TIE-DYE OUTERWEAR

Looking for some fun outerwear options?? We got you covered with tie-dye options! Tie-dye options are a great way to have some fun apparel options for the summer.

## CALL FOR A CUSTOM QUOTE



Crewnecks

\*Inventory and pricing subject to change confirm with your sales rep

**CONTACT YOUR LOCAL SALES REP FOR MORE INFORMATION**



# DESIGN SERVICES

Looking for some great art/design ideas? Our designers here at Team Phun can help with that. From simple vector artwork conversions to expert branding and company brand guideline development - we have you covered!

Custom Artwork Process Example:



Let our team of designers work closely with you to create one-of-a-kind graphics and designs that will help elevate your brand.

Talk to a sales rep today to learn more about all the design services we offer.

# SUMMER PHUN



**CONTACT YOUR LOCAL SALES REP FOR MORE INFORMATION**



# TEAM PHUN ORIGINALS



## SCREEN PRINTED T-SHIRTS, HOODIES, AND MORE

Team Phun offers multiple forms of screen printing decorations; including plastisol, discharge, water base and foil transfer. Whether it's mens, womens, unisex or kids. We can service both large and small quantities without sacrificing quality.

- **Minimum order 48 units**

**CALL FOR A CUSTOM QUOTE**

## WOMEN'S CROP TOPS

Create a more curated selection of women's tees with printed crop tops. Your brand will stand out all spring long!

**Style: W1085 Women's Crop Top**

**Color Options: White, Black, Athletic Heather**

**Sizes: XS, S, M, L, XL**

**CALL FOR A CUSTOM QUOTE**



Product Description:  
24 single, 5.5 oz., soft-washed,  
100% combed ring-spun cotton. Crew Neck,  
drop shoulder, ultra soft hand, side-seamed,  
tightly knit, superior printability.

\*Inventory subject to change. Please confirm stock with your sales rep

**CONTACT YOUR LOCAL SALES REP FOR MORE INFORMATION**

TEAM PHUN  
ORIGINALS



## WOMEN'S RACERBACK TANK

Whether it's a spring uniform or an addition to your apparel collection, branded women's racer back tank tops are a best seller at Team Phun! 3.9oz 60/40 combined ringspun cotton/polyester.

**Style: NL1533 Women's Ideal Racerback Tank**

**Sizes: XS, S, M, L, XL, 2XL**



**CALL FOR A CUSTOM QUOTE**

\*Inventory subject to change. Please confirm stock with your sales rep

**CONTACT YOUR LOCAL SALES REP FOR MORE INFORMATION**



# TEAM PHUN ORIGINALS



## EMBOSSSED T-SHIRTS, HOODIES, AND MORE

Stand out, LITERALLY! With custom made cut and sewn embossed apparel, your company logo or graphic will be sure to make a statement! Whether it's mens, womens, unisex or kids. We can service both large and small quantities without sacrificing quality. 100% cotton.

- **Minimum order 200 units. 30 pieces per size.**

**CALL FOR A CUSTOM QUOTE**

## WOMEN'S LEGGINGS

There's nothing more upsetting than heading out for a quick jog in leggings and realizing there's nowhere to put your phone or keys. Enter these performance leggings, full-length compression leggings with side pockets to place belongings made in a soft stretch fabric to keep your customers comfy. Perfect for athletic studios, running clubs, or CrossFit!!

**Style:TD531 TriDri Ladies Performance Leggings**  
**Color Options: Black, Charcoal, Navy**  
**Sizes: XS, S, M, L, XL, 2XL**

**CALL FOR A CUSTOM QUOTE**



Product Description:  
7.67oz 90% recycled polyester, 10% elastane.  
Elasticated waistband, side pockets, soft-stretch fabric, Full-length compression legging, tear away label

\*Inventory subject to change. Please confirm stock with your sales rep

**CONTACT YOUR LOCAL SALES REP FOR MORE INFORMATION**



# TEAM PHUN ORIGINALS



## CUSTOM POCKET TEES (A) MADE IN U.S.A.

Custom pocket tees are a great way to bring a standard t-shirt to life with your brand. Through full sublimation, there is no limit on colors, imagery, or patterns. \$65.00 set up

**MADE IN USA**

**CALL FOR A CUSTOM QUOTE**

## EMBROIDERED POLOS

Use embroidery to showcase your brand and bring your team together with uniformed polos!

We carry:



**CALL FOR A CUSTOM QUOTE**

*\*Inventory subject to change. Please confirm stock with your sales rep*

**CONTACT YOUR LOCAL SALES REP FOR MORE INFORMATION**

# TEAM PHUN ORIGINALS



## CUSTOM PATCHES

Turn your logo into a custom patch for hats, bags, jackets and more! Look through hundreds of styles and colors to best showcase your brand. Patches are also great for other accessories!

**MOQ: 100**

**Patches sewn onto garments in USA**

### CALL FOR A CUSTOM QUOTE



Looking for something a bit more unique? Take your patches to the next level and create a PVC patch!

**MOQ:**

**Patches sewn onto garments in USA**



## EMBROIDERED HEADWEAR

Use embroidery to show off your brand all year round on all styles of headwear!

We carry:



# CONTACT YOUR LOCAL SALES REP FOR MORE INFORMATION



# TEAM PHUN ORIGINALS



## FULL CUSTOM HAT

Through our comprehensive design process with in-house graphic designers, and knowledgeable sales reps, Team Phun can make your custom hat dreams come true!

**MOQ: 144**

## CALL FOR A CUSTOM QUOTE



\*Inventory subject to change. Please confirm stock with your sales rep

**CONTACT YOUR LOCAL SALES REP FOR MORE INFORMATION**



# TEAM PHUN ORIGINALS



CPN-558303594

## BEST SELLER - CAMPER MUG (A)

Comparable to a Yeti mug, this Camper mug is a 12oz double walled stainless steel thermal mug with copper vacuum insulation. Add your company logo and use as employee gifts or for retail!

### CALL FOR A CUSTOM QUOTE

- Includes retail friendly box
- Full color logo options available



## ACRYLIC TUMBLER - GEO (A)

This Geo acrylic tumbler has a clear outer wall, colored geometric inner wall, push-on dual purpose swivel lid, and matching soft straw. Perfect for any outdoor event!

### CALL FOR A CUSTOM QUOTE



CPN-556577901

\*Inventory and pricing subject to change confirm with your sales rep

**CONTACT YOUR LOCAL SALES REP FOR MORE INFORMATION**

**TEAM PHUN  
ORIGINALS**



CPN -558597422

## FULL WRAP DECORATION - H2GO JOURNEY (A)

Work with Team Phun to create a full-wrap design to show off your brand while quenching your thirst! The H2GO Ascent is a 24oz double-walled stainless steel thermal bottle to keep your drink cold or hot.

### CALL FOR A CUSTOM QUOTE



stainless



matte white



matte red



matte orange



matte lime



matte mint



matte aqua



matte navy



matte black

\*Inventory and pricing subject to change confirm with your sales rep

**CONTACT YOUR LOCAL SALES REP FOR MORE INFORMATION**



# TEAM PHUN ORIGINALS



CPN-558324672



black

denim

## BEST SELLER BACKPACK - PRESIDIO (C)

With a custom laser etched leather patch, the Presidio backpack is a great way to showcase your brand in a unique way. Includes a memory foam back panel, adjustable straps and can fit most 17" laptops with side zip access.

**CALL FOR A CUSTOM QUOTE**



\*leather patch close up

## CARHARTT CANVAS DUFFEL BAG (A)

This versatile duffel keeps water out and can hold all your job site or travel must-haves. Comes folded inside a utility pouch that can be reused to hold additional tools and gear. Customize with your logo to show off your brand on site.

**CALL FOR A CUSTOM QUOTE**

- Includes 7,000 stitch embroidered logo



Product #: CT89105112  
CPN-559627286



black



carhartt brown

\*Inventory subject to change. Please confirm stock with your sales rep

**CONTACT YOUR LOCAL SALES REP FOR MORE INFORMATION**

# TEAM PHUN ORIGINALS



Product #: A310  
CPN-5556830311

## ADIDAS WEEKEND DUFFEL BAG (A) SC

Whether you give them as a gift or sell for retail, these Adidas duffel bags are a great way to show off your brand. Perfect for a weekend get-away bag, or everyday gym bag!

- Includes 7,000 Stitch Embroidery

**CALL FOR A CUSTOM QUOTE**



collegiate royal/  
black



collegiate burgundy/  
black



collegiate navy/  
black



collegiate red/  
black



black/black



grey/black

## BEACH PARTY BAG (A)

Be prepared this summer with the durable Rolling Cooler! Show off your brand at any outdoor event while keeping your food and beverages cool. Includes heat transfer or embroidered logo on front panel

**CALL FOR A CUSTOM QUOTE**



black



red



twilight blue

Product #: BG119  
CPN-12703824



\*Inventory subject to change. Please confirm stock with your sales rep

**CONTACT YOUR LOCAL SALES REP FOR MORE INFORMATION**



# TEAM PHUN ORIGINALS



## ECO FRIENDLY TOTE (A) CASS

Looking for an eco-friendly giveaway item? This light, compact carryall tote is a great way to show off your brand and reduce the use of single-use plastic at the same time! Cost includes 4 color screenprint logo and set ups.

## CALL FOR A CUSTOM QUOTE



natural/black



natural/hunter



natural/red



natural/navy



black



sterling grey



red



navy

## RECYCLED PLASTIC BAGS!



Team Phun offers multiple bag options made from recycled materials so you feel good when using it knowing it's good for the planet!

\*Ask your local sales rep about the perfect eco-friendly option for you!

## CALL FOR A CUSTOM QUOTE



Solo® Re:vive Mini Backpack



Sherpani Camden Hybrid backpack



Solo® Re:new Briefcase



Solo® Re:move Duffel



Solo® Re:focus 13" Sleeve

\*Inventory subject to change. Please confirm stock with your sales rep

# CONTACT YOUR LOCAL SALES REP FOR MORE INFORMATION

# TEAM PHUN ORIGINALS



SKU: DR10x10

## FULLY SUBLIMATED 10 X 10 CANOPY (CA)

Get ready for outdoor events with this sublimated 10' x 10' canopy tent. With no limit on colors, show off your brand to its fullest and stand out from the rest!

\*Shipping Included!

Package Includes:

- Aluminum Frame (Hex leg thickness: 40mm)
- Black Nylon Bag with wheels
- Full Color Dye Sub Printed Top on 600D PU Coated Polyester
- (4) Ropes and (4) Groundspikes

**CALL FOR A CUSTOM QUOTE**

## RETRACTABLE BANNERS

Make yourself visible with these full package retractable banners! Includes hardware and a canvas carry bag for easy storing and reuse.

**CALL FOR A CUSTOM QUOTE**



SKU: DR-Xstand 32x71



SKU: MINI 11X17 - SPECIAL



SKU: DR-33 Scroll Full Package

\*Inventory subject to change. Please confirm stock with your sales rep

**CONTACT YOUR LOCAL SALES REP FOR MORE INFORMATION**



## VINYL/FABRIC BANNERS

Our banners are fully sublimated to give you a max imprint area to show off your brand. Offered in a wide variety of sizes there is no limit to where your banner can go! Work with Team Phun to create a unique design or use your own.

**CALL FOR A CUSTOM QUOTE**

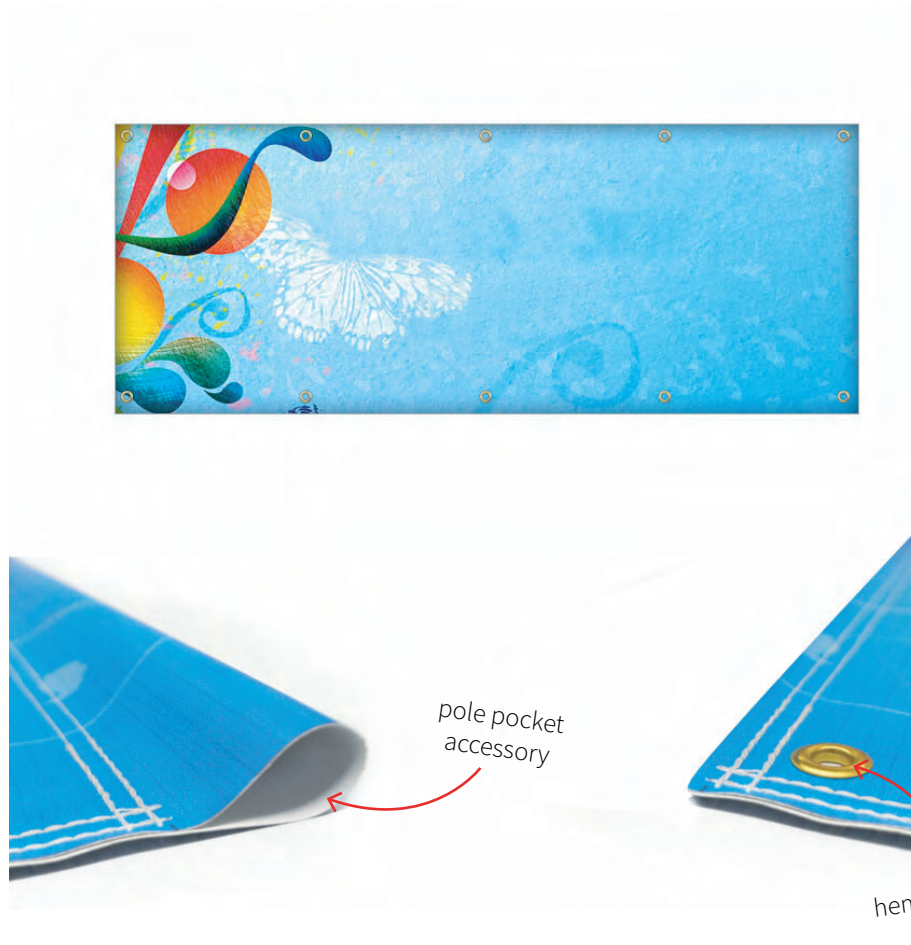

\*Inventory subject to change. Please confirm stock with your sales rep

**CONTACT YOUR LOCAL SALES REP FOR MORE INFORMATION**

**TEAM PHUN  
ORIGINALS**



# TEAM PHUN ORIGINALS



## TABLE COVERS (A) CA

With a full color custom dye sublimated print, your brand will stand out at any trade show, exhibition, and/or presentation! We offer fitted, loose, and convertible table covers.

**CALL FOR A CUSTOM QUOTE**



1 Color Imprint



Table Runners



Stretch Fitted



Box Style

\*Inventory subject to change. Please confirm stock with your sales rep

**CONTACT YOUR LOCAL SALES REP FOR MORE INFORMATION**



# FLOORMATS - BRANDING AT YOUR FEET

Never miss an opportunity for your brand to be visible with indoor and outdoor floormats! Work with your local sales rep to find the best floormats for you. Check out some of our top floormats below and ask your local sales rep for our other options.

## CALL FOR A CUSTOM QUOTE



### Flocked Camelot

- 14 oz. close-knit polypropylene fiber constructed in parallel rows
- Raised nylon flock imprint (3-Dimensional)
- Overall mat thickness: 1/4"
- Heavy-duty vinyl backing
- Custom shapes and sizes available



### Flocked Coco Brush

- Natural coconut husk fiber construction
- Raised nylon flock imprint (3-Dimensional)
- Overall mat thickness: 1/2"
- Heavy duty vinyl backing
- Custom sizes available



### Nylon Dye Twist

- 20 oz. nylon twisted yarn
- Injection dye imprint process
- Overall mat thickness: 3/8"
- Machine washable rubber backing
- Custom sizes available

\*Inventory subject to change. Please confirm stock with your sales rep

**CONTACT YOUR LOCAL SALES REP FOR MORE INFORMATION**

**TEAM PHUN  
ORIGINALS**



# TEAM PHUN ORIGINALS



## COOLERS

Raise the bar with a new and exclusively unique cooler. With a built-in bottle opener, bottle cap catcher, lower shelf and an elevatable lid. This cooler is able to be fully wrapped and imprinted on top! What an ultimate display item.

**CALL FOR A CUSTOM QUOTE**

## COUNTER MATS

Krystex Peel & Place Ultra Thin Counter Mats are a highly visible inexpensive way to deliver your message on counter tops everywhere! Your brilliant color image is protected under our tough Krystex smooth gloss surface. Let your brand stand out with custom counter mats!

**CALL FOR A CUSTOM QUOTE**



\*Inventory may be subject to set up fee. Minimum quantities apply, confirm with your sales rep

**CONTACT YOUR LOCAL SALES REP FOR MORE INFORMATION**



# TEAM PHUN ORIGINALS



## CUSTOM STICKERS (A)

Stickers have become the new business card and we want yours to be as unique as your brand! Choose from many options like die-cut, reflective, and/or transparent.

**CALL FOR A CUSTOM QUOTE**

## KOOZIES - MADE IN USA

Have your brand front and center all summer long with custom koozies. Whether it's fully sublimated or a one color print, your brand will stand out from the rest!

**CALL FOR A CUSTOM QUOTE**



\*Inventory may be subject to set up fee. Minimum quantities apply, confirm with your sales rep

**CONTACT YOUR LOCAL SALES REP FOR MORE INFORMATION**

# TEAM PHUN ORIGINALS



## PINS

Create a unique pin to have your customer carry around with them wherever they go! Add custom card backings for a retail ready pin!

**CALL FOR A CUSTOM QUOTE**

add custom card backing

FRONT



BACK



PIN TYPES

soft enamel



hard enamel



printed epoxy

diestruck



\*Inventory subject to change. Please confirm stock with your sales rep

**CONTACT YOUR LOCAL SALES REP FOR MORE INFORMATION**



# TEAM PHUN ORIGINALS



CPN-558663047



Royal Blue

Red

Black

## PATIO UMBRELLAS (A)

With an 84" arc and six printable panels, your logo will be seen all summer long on these patio umbrellas. The canopy is a deluxe color-fast fabric and is removable for easy cleaning and inexpensive replacement.

**CALL FOR A CUSTOM QUOTE**

## CAFE MARKET UMBRELLAS

Shade your outdoor seating area with the Vented Cafe Market Umbrella that has 6 printable panels, along with a three-position tilting device. Best of all, it has a removable canopy for easy cleaning.

**CALL FOR A CUSTOM QUOTE**



Black

Lime Green

Orange

Royal Blue

Teal

Red



CPN-557668611

\*Inventory subject to change. Please confirm stock with your sales rep

**CONTACT YOUR LOCAL SALES REP FOR MORE INFORMATION**

# CUSTOM PACKAGING

Product packaging should be attractive, well-designed to protect what's inside, and make the consumer excited about your product. Team Phun can create custom packaging for your brand/company! We design shipping boxes, to-go boxes/bags, food wrappers, and even retail-ready display boxes.

## CALL FOR A CUSTOM QUOTE

add custom modifications

choose the style of box

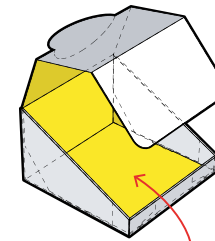
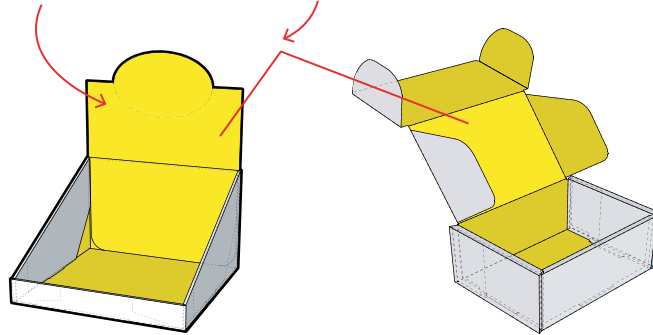

personalize with your branding

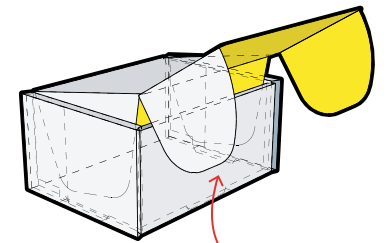

dual purpose packaging for shipping

# TEAM PHUN ORIGINALS



**CONTACT YOUR LOCAL SALES REP FOR MORE INFORMATION**



# CUSTOM KITTING

Kits are becoming very common in the digital age supporting consumers, employees, companies, and experiences worldwide. Team Phun elevates the experience of getting merchandise (whether for promo, retail, health, etc) by curating custom products, packaging, and global logistics for the end-users. With our team of designers, engineers, and operational partners, we have a kit for every occasion.

## CALL FOR A CUSTOM QUOTE



# TEAM PHUN ORIGINALS



**CONTACT YOUR LOCAL SALES REP FOR MORE INFORMATION**

# TEAM PHUN ORIGINALS



## E-COMMERCE STORE BUILDS

Did you know that Team Phun can build and host your company's e-commerce shop and store your inventory? Let us show you our capabilities!

### CALL FOR A CUSTOM QUOTE

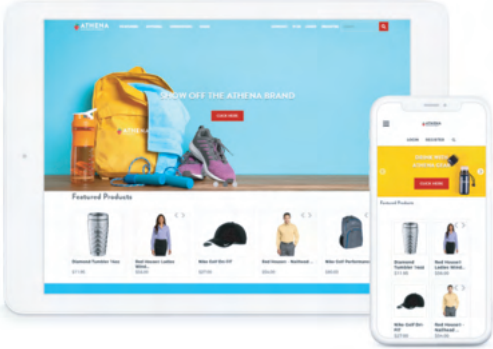
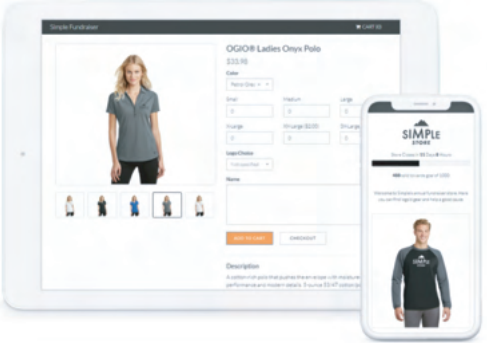
COMPANY STORES	SIMPLESTORES
<ul style="list-style-type: none"><li>• Fully customizable online stores.</li><li>• Homepage, product categories, and product pages for a retail experience</li><li>• Located with features like permissions, budgets, and user accounts</li><li>• A variety of store levels and add-ons available to meet your clients' needs</li><li>• Perfect for providing a centralized corporate ordering location</li></ul>	<ul style="list-style-type: none"><li>• Quick and easy online ordering</li><li>• All products and product options are listed on a single storefront page</li><li>• Limited feature options for a fast setup and store launch</li><li>• Affordable so you can give all of your clients the option to order online</li><li>• Perfect for temporary pop-ups, schools, and fundraisers</li></ul>
	

**CONTACT YOUR LOCAL SALES REP FOR MORE INFORMATION**



# TEAM PHUN FULFILLMENT PROGRAM

Not only can we manage your e-commerce inventory, BUT we can ALSO manage shipping of the product directly to your consumers/clients! Here at Team Phun, we manage all aspects of fulfillment!

**CALL FOR A CUSTOM QUOTE**

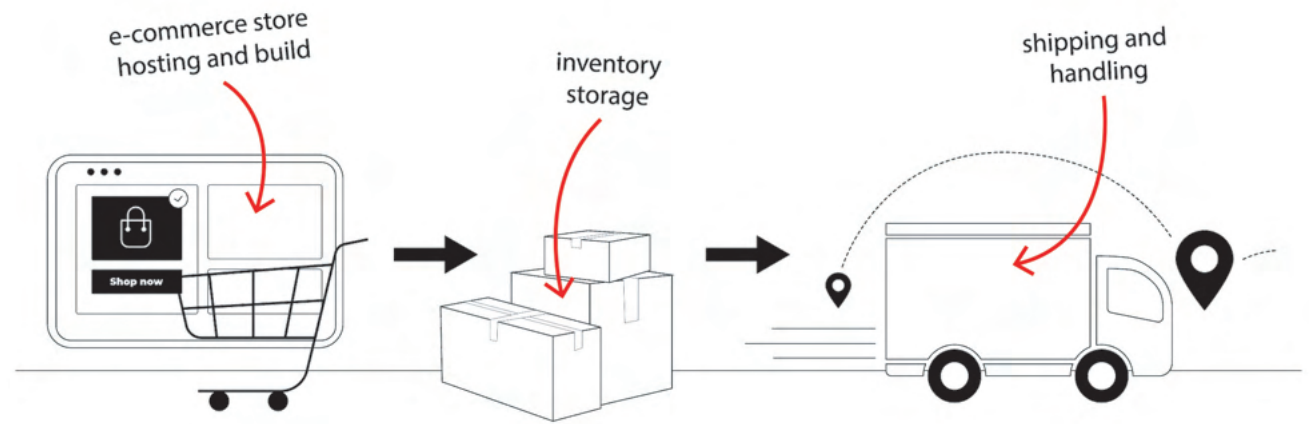

**TEAM PHUN  
ORIGINALS**



**CONTACT YOUR LOCAL SALES REP FOR MORE INFORMATION**

# TEAM PHUN ORIGINALS



## BRANDED KN95S

As Covid has evolved, so have we. This is why we are now offering branded and unbranded KN95s to make sure you and your team are kept as safe as possible.

**CALL FOR A CUSTOM QUOTE**

## TRAVEL SANITIZERS

Encourage the health of those around you with travel sanitizers. Don't just give out sanitizer, but make sure your brand stands out! Great for conferences, tradeshow and gifts to clients.

**CALL FOR A CUSTOM QUOTE**



## TEST KITS

Covid-19 Antigen Home Tests.  
LIMITED QUANTITY AVAILABLE

\*Inventory subject to change. Please confirm stock with your sales rep

**CONTACT YOUR LOCAL SALES REP FOR MORE INFORMATION**



# TEAM PHUN ORIGINALS



## CUSTOM CUT AND SEW MERCH

Team Phun has an extensive custom cut & sew sublimated merchandise program that will create meaningful engagement with your consumers and build an experience around your brand. From totes to windbreakers and a whole lot more inventory to choose from. Start today!

### CALL FOR A CUSTOM QUOTE



#### **Woven Button-up Shirt - MFTPS2102**

- 85 / 15 poly cotton woven
- Fashion / Unisex Fit
- Cotton Feel



#### **Cotton Canvas Tote Bag - MFACC2010**

- Front zipper pocket
- Customizable front pocket
- Custom printed woven label
- Natural color 100% Cotton Canvas



#### **Windbreaker Jacket - MFOUT2403**

- Front Zipper / Customizable inside moon patch
- 100% Polyester Micro Suede
- Waterproof
- Unisex / Fashion Fit

\*Inventory subject to change. Please confirm stock with your sales rep

**CONTACT YOUR LOCAL SALES REP FOR MORE INFORMATION**